

Data Sheet



Article number: 03441140

Description: Fluro Rod end GE 140EC-2RS

Measures

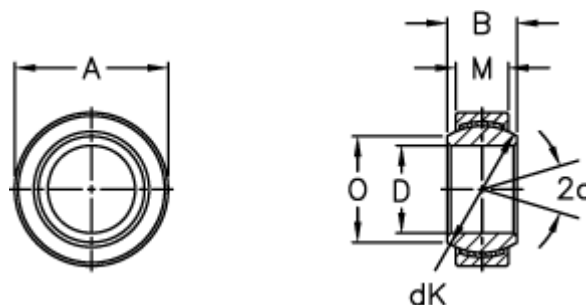

A = 210 0 -0,030

B = 90

D = 140 0 -0,025

dK = 180

Dynamic load C (kN) = 2010

M = 70

O = 155.8

Static load C0 (kN) = 4020

Tilt angle = 7

Weight = 11000